

* Collector Dissipation: $P_c=225\text{mW}$

* Collector-Emitter Voltage : $V_{ce0}=40\text{V}$

ABSOLUTE MAXIMUM RATINGS at $T_a=25$

Characteristic	Symbol	Rating	Unit
Collector-Base Voltage	V_{cbo}	60	V
Collector-Emitter Voltage	V_{ceo}	40	V
Emitter-Base Voltage	V_{ebo}	6	V
Collector Current	I_c	600	mA
Collector Dissipation $T_a=25$ *	P_D	225	mW
Junction Temperature	T_j	150	
Storage Temperature	T_{stg}	-55-150	

Package:SOT-23

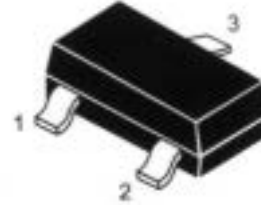

PIN:	1	2	3
STYLE			
NO.1	B	E	C

ELECTRICAL CHARACTERISTICS at $T_a=25$

Characteristic	Symbol	Min	Typ	Max	Unit	Test Conditions
Collector-Base Breakdown Voltage	BV_{cbo}	60			V	$I_c=100\mu\text{A}$ $I_e=0$
Collector-Emitter Breakdown Voltage#	BV_{ceo}	40			V	$I_c=1\text{mA}$ $I_b=0$
Emitter-Base Breakdown Voltage	BV_{ebo}	6			V	$I_e=100\mu\text{A}$ $I_c=0$
Emitter Cutoff Current	I_{cex}			100	nA	$V_{ce}=35\text{V}$ $V_{eb}=-0.4\text{V}$
Collector Cutoff Current	I_{bev}			-100	nA	$V_{eb}=0.4\text{V}$ $V_{ce}=35\text{V}$
DC Current Gain	H_{fe1}	20				$V_{ce}=1\text{V}$ $I_c=0.1\text{mA}$
DC Current Gain	H_{fe2}	40				$V_{ce}=1\text{V}$ $I_c=1\text{mA}$
DC Current Gain	H_{fe3}	80				$V_{ce}=1\text{V}$ $I_c=10\text{mA}$
DC Current Gain	H_{fe4}	100		300		$V_{ce}=1\text{V}$ $I_c=150\text{mA}$
DC Current Gain	H_{fe5}	40				$V_{ce}=2\text{V}$ $I_c=500\text{mA}$
Collector-Emitter Saturation Voltage	$V_{ce(sat)}$			0.4	V	$I_c=150\text{mA}$ $I_b=15\text{mA}$
Collector-Emitter Saturation Voltage	$V_{ce(sat)}$			0.75	V	$I_c=500\text{mA}$ $I_b=50\text{mA}$
Base-Emitter Saturation Voltage	$V_{be(sat)}$	0.75		0.95	V	$I_c=150\text{mA}$ $I_b=15\text{mA}$
Base-Emitter Saturation Voltage	$V_{be(sat)}$			1.2	V	$I_c=500\text{mA}$ $I_b=50\text{mA}$
Output Base Capacitance	C_{ob}			6.5	PF	$V_{cb}=5\text{V}$ $I_e=0$ $f=1\text{MHz}$
Emitter Base Capacitance	C_{eb}			30	PF	$V_{cb}=5\text{V}$ $I_e=0$ $f=1\text{MHz}$
Current Gain-Bandwidth Product	f_T	250			MHz	$V_{ce}=20\text{V}$ $I_c=10\text{mA}$ $F=100\text{MHz}$

* Total Device Dissipation : $FR=1 \times 0.75 \times 0.062\text{in Board}$, Derate 25 .

Pulse Test : Pulse Width 300uS, Duty cycle 2%

DEVICE MARKING:

MMBT4401=2X

MMBT4401

SWITCHING TIME EQUIVALENT TEST CIRCUITS

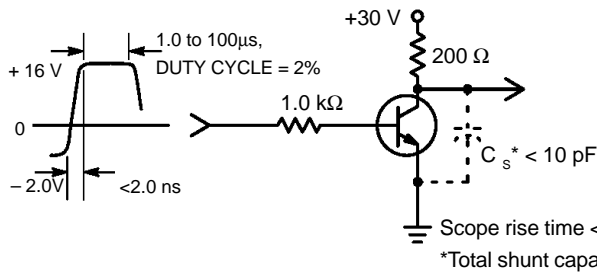

Figure 1. Turn-On Time

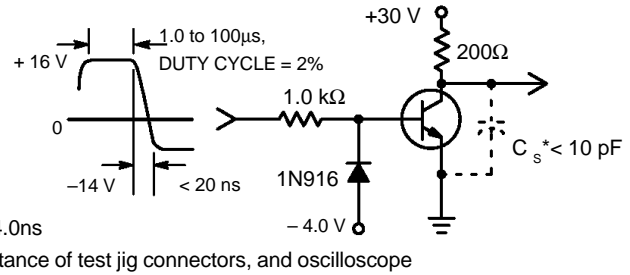

Figure 2. Turn-Off Time

SMALL-SIGNAL CHARACTERISTICS

NOISE FIGURE

$V_{CE} = 10 \text{ Vdc}$, $T_A = 25^\circ\text{C}$

Bandwidth = 1.0 Hz

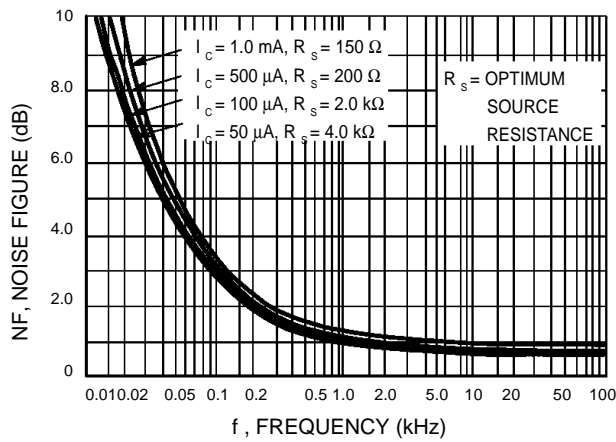

Figure 3. Frequency Effects

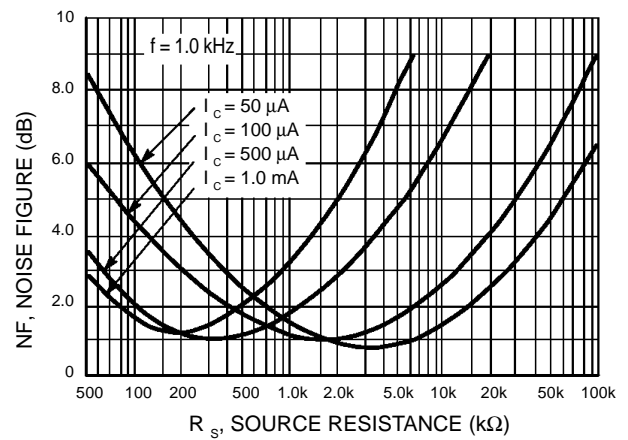
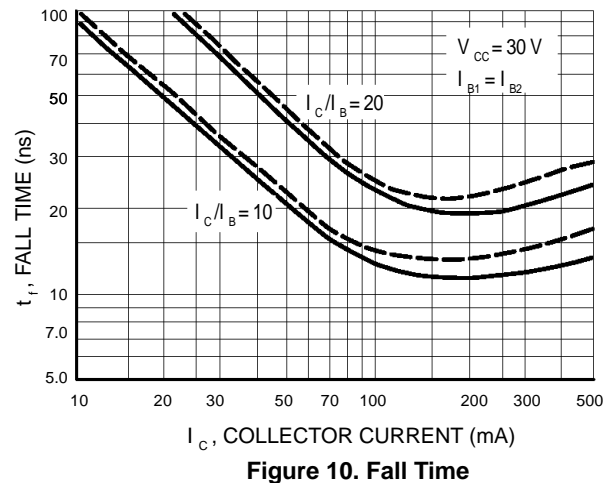
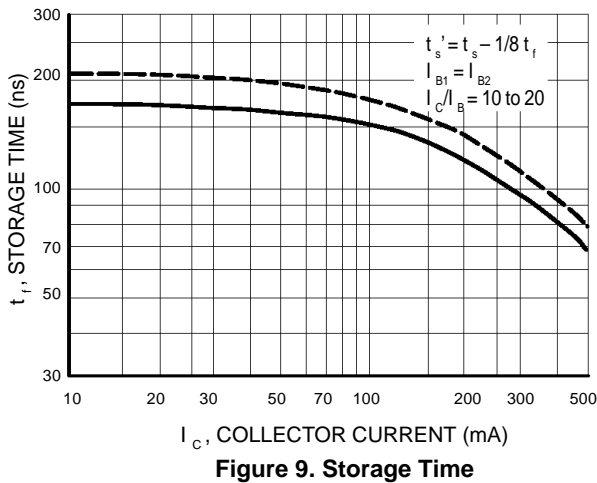
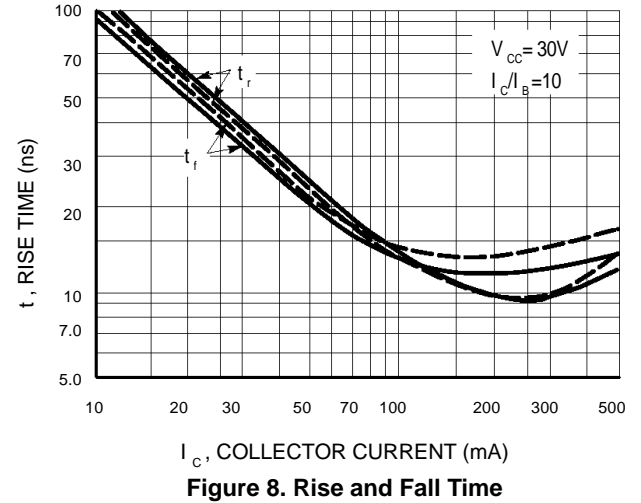
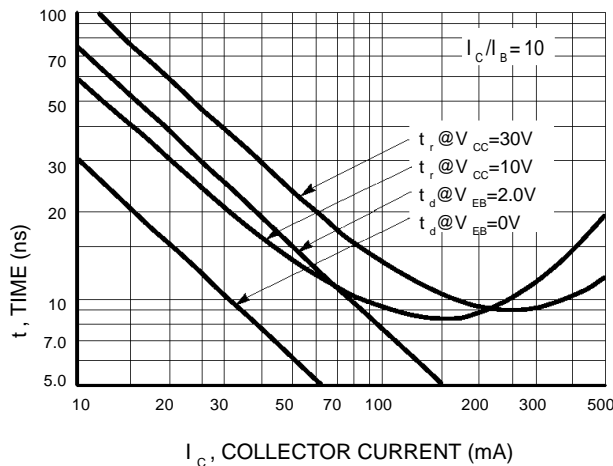
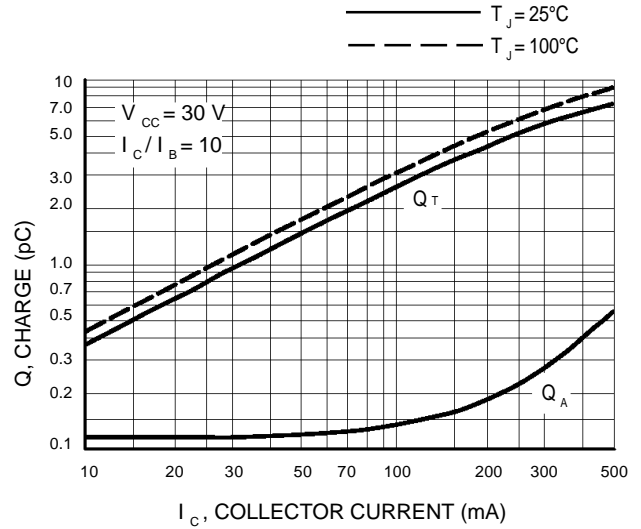
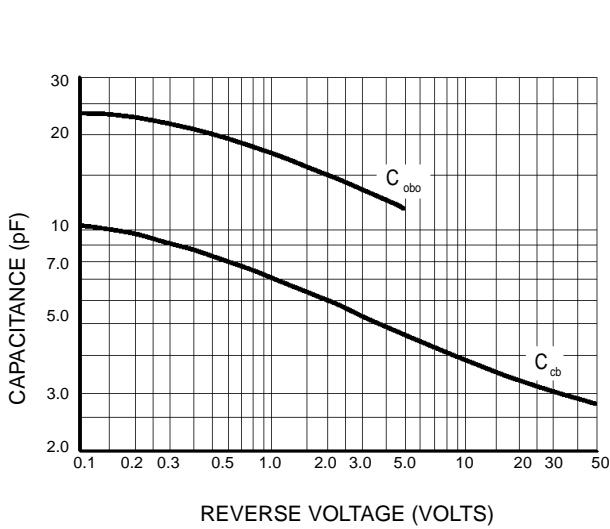

Figure 4. Source Resistance Effects

MMBT4401

TRANSIENT CHARACTERISTICS



MMBT4401

STATIC CHARACTERISTICS

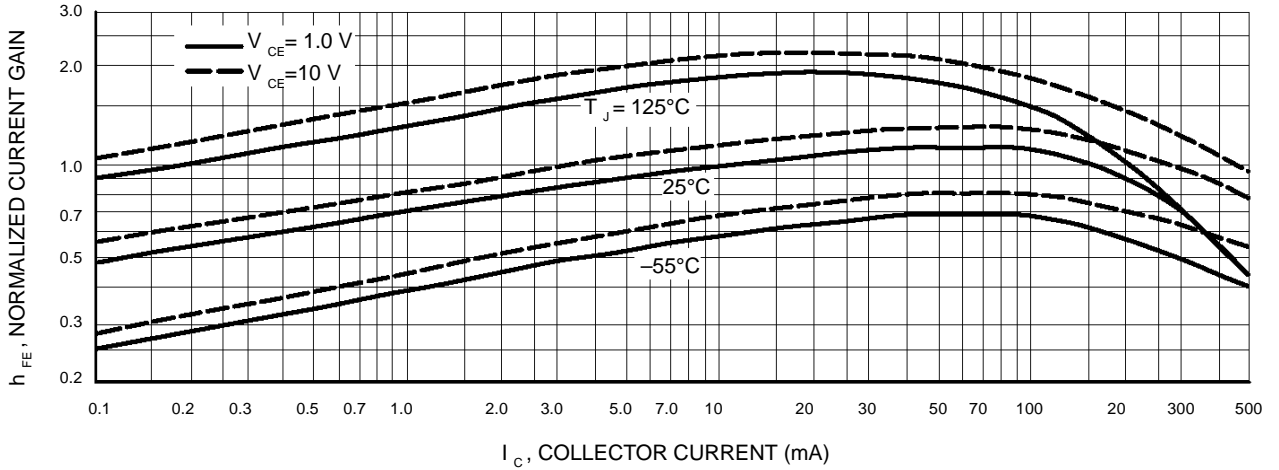

Figure 11. DC Current Gain

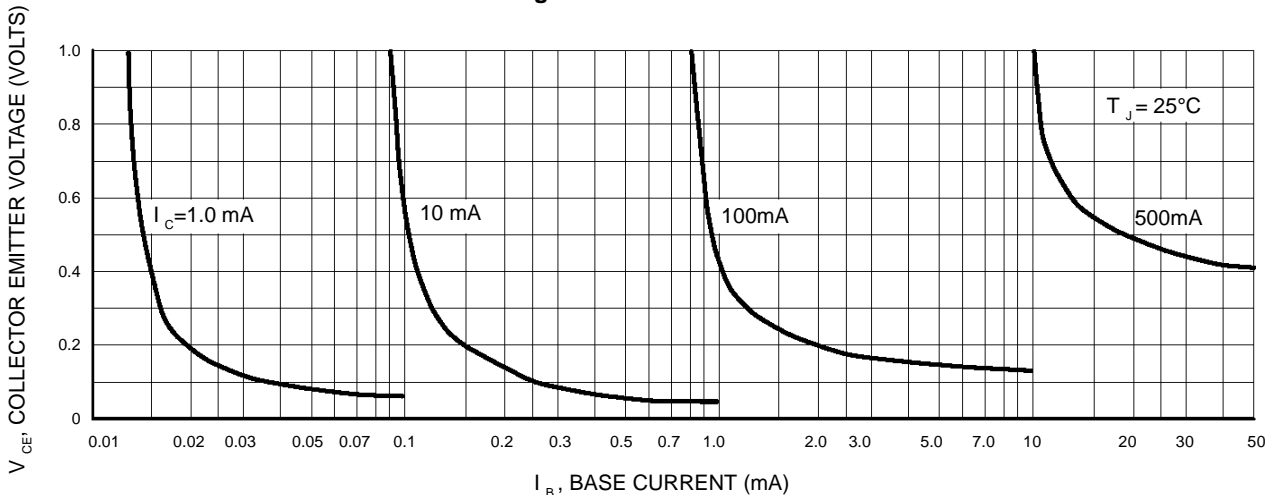

Figure 12. Collector Saturation Region

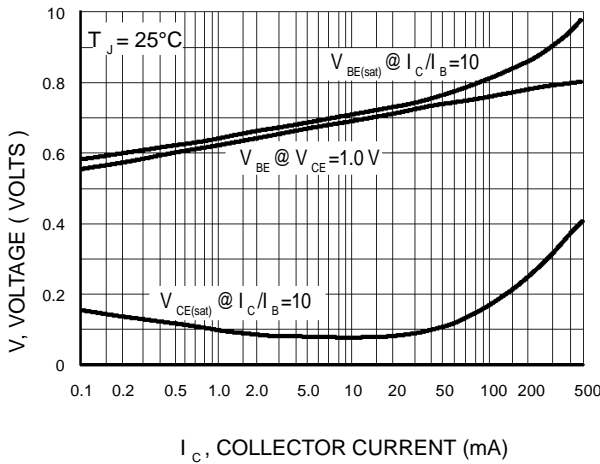

Figure 13. "On" Voltages

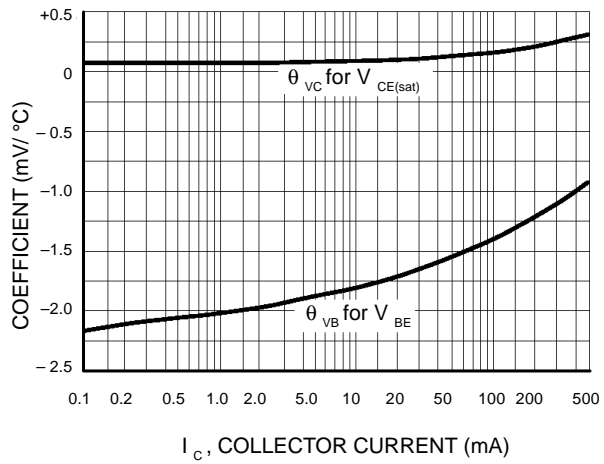
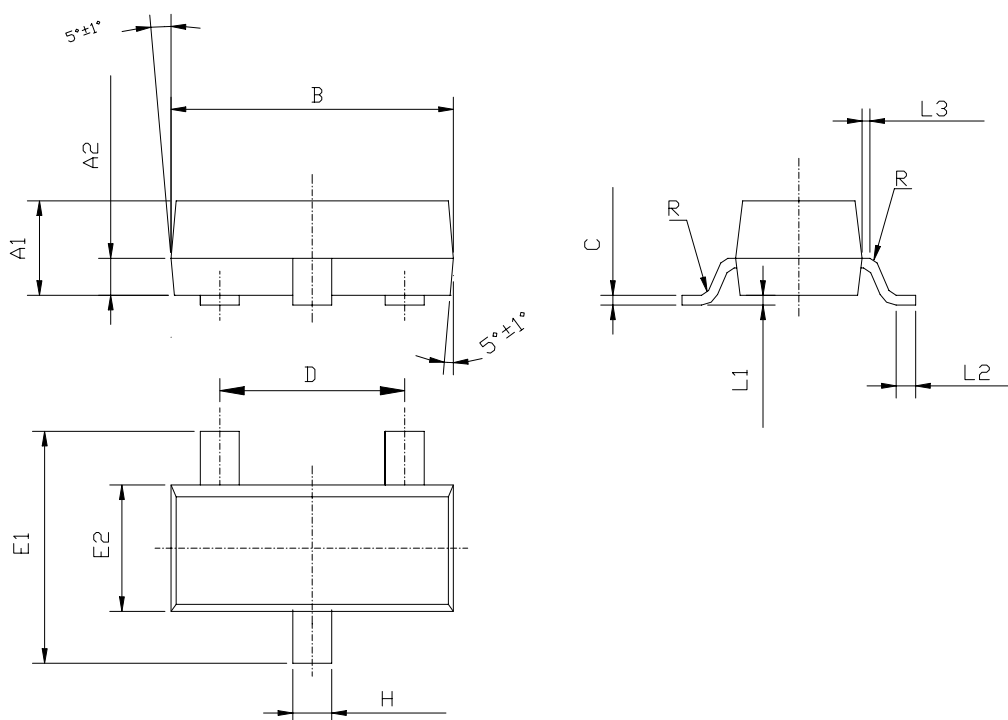
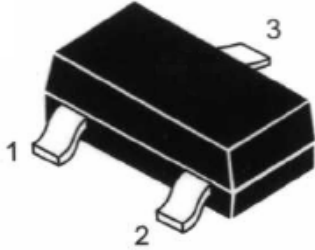

Figure 14. Temperature Coefficients





Symbol	Dimensions in Millimeters			内部结构 STYLS	管脚 PIN		
	Min	Nominal	Max		1 脚	2 脚	3 脚
A1	0.900	0.970	1.000	6	基极 BASE	发射极 EMITTER	集电极 COLLECTOR
A2	0.350	0.380	0.410		8	阳极 ANODE	不连接 NO- CONNECTION
B	2.800	2.900	3.000	9		阳极 ANODE	阳极 ANODE
C	0.085	0.100	0.150		11	阳极 ANODE	阴极 CATHODE
D	1.800	1.900	2.000	12		阴极 CATHODE	阴极 CATHODE
E1	2.200	2.400	2.600		18	不连接 NO- CONNECTION	阴极 CATHODE
E2	1.200	1.300	1.400	19		阴极 CATHODE	阳极 ANODE
H	0.300	0.400	0.500				
L1	0.000		0.100				
L2	0.200						
L3	0.030	0.080	0.130				
R	0.080TYP						



OUTSIDE

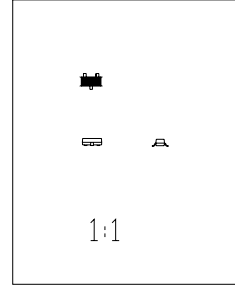

Scale 1:1 on letter size paper

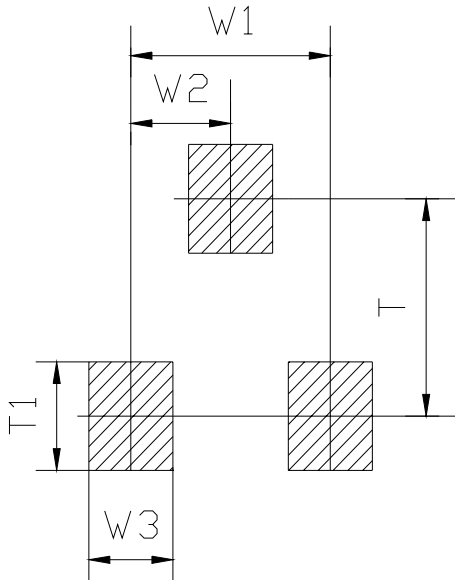

FOOTPRINTS FOR SOLDERING

Symbol	Dimensions in Millimeters	Dimensions in Inches
	Nominal	Nominal
W1	1.900	0.0748
W2	0.950	0.0374
W3	0.800	0.0315
T	2.000	0.0787
T1	1.000	0.0394

SOT-23 PACKAGING:

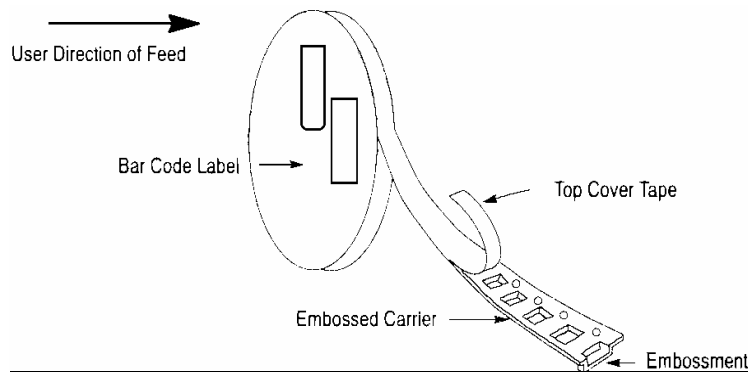

SOT-23 EMBOSSED CARRIER TAPE:

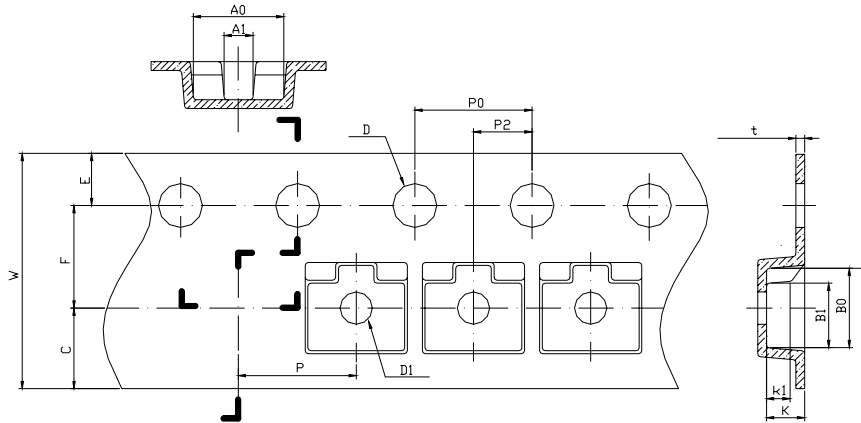

Symbol	Dimensions in Millimeters			Dimensions in Inches		
	Minimum	Nominal	Maximum	Minimum	Nominal	Maximum
A0	3.050	3.150	3.250	0.1201	0.1240	0.1280
A1	0.900	1.000	1.100	0.0354	0.0394	0.0433
B0	2.669	2.769	2.869	0.1051	0.1090	0.1130
B1	2.100	2.200	2.300	0.0827	0.0866	0.0906
C	2.750TYP			0.1083TYP		
D	1.500	1.500	1.600	0.0591	0.0591	0.0630
D1	0.900	1.000	1.100	0.0354	0.0394	0.0433
E	1.650	1.750	1.850	0.0650	0.0689	0.0728
F	3.450	3.500	3.550	0.1358	0.1378	0.1398
K	1.119	1.219	1.319	0.0441	0.0480	0.0519
K1	0.850TYP			0.03346TYP		
P	3.900	4.000	4.100	0.1535	0.1575	0.1614
P0	3.900	4.000	4.100	0.1535	0.1575	0.1614
P010	39.800	40.000	40.200	1.5669	1.5748	1.5827
P2	1.950	2.000	2.050	0.0768	0.0787	0.0807
t	0.216	0.229	0.242	0.0085	0.0090	0.0095
W	7.900	8.000	8.300	0.3110	0.3150	0.3268

SOT-23 REEL DATA:

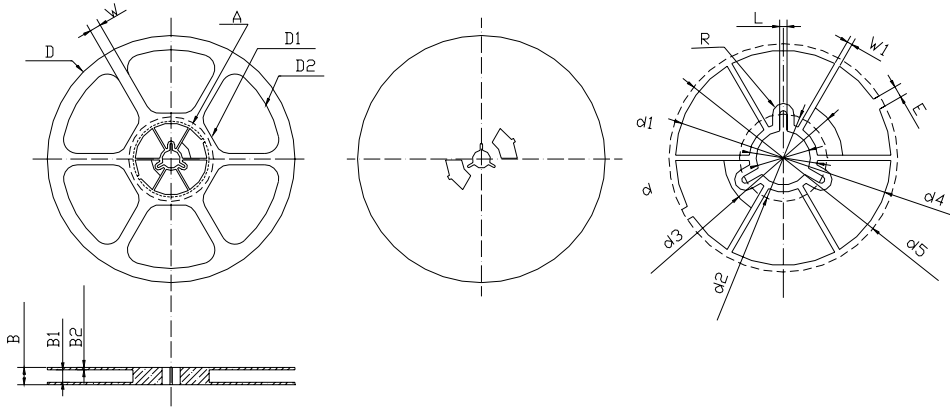

Symbol	Dimensions in Millimeters			Dimensions in Inches		
	Minimum	Nominal	Maximum	Minimum	Nominal	Maximum
B	-	-	12.500	-	-	0.4921
B1	8.900	9.000	9.100	0.3504	0.3543	0.3583
B2	1.700	1.750	1.800	0.0669	0.0689	0.0709
D	ϕ 177.000	ϕ 178.000	ϕ 179.000	Φ 6.9685	Φ 7.0079	Φ 7.0472
D1	Φ 67.600TYP			Φ 2.6614TYP		
D2	Φ 157.600TYP			Φ 6.2047 TYP		
d	Φ 12.800	Φ 13.000	Φ 13.200	Φ 0.5039	Φ 0.5118	Φ 0.5197
d1	Φ 16.40 TYP			Φ 0.6457 TYP		
d2	Φ 21.000 TYP			Φ 0.8268 TYP		
d3	Φ 25.200 TYP			Φ 0.99221TYP		
d4	Φ 50.600	Φ 51.600	Φ 52.600	Φ 1.9921	Φ 2.0315	Φ 2.0709
d5	Φ 53.800	Φ 54.800	Φ 55.800	Φ 2.1181	Φ 2.1575	Φ 2.1969
E	2.800 TYP			0.1102TYP		
L	1.750 TYP			0.0689 TYP		
R	2.575 TYP			0.1014 TYP		
W	15.000 TYP			0.5906 TYP		
W1	1.300 TYP			0.0512 TYP		