

- * Collector Current : $I_c = -800\text{mA}$
- * High Total Power Dissipation : $P_c = 300\text{mW}$

ABSOLUTE MAXIMUM RATINGS at $T_a = 25^\circ\text{C}$

Characteristic	Symbol	Rating	Unit
Collector-Base Voltage	V_{cbo}	-40	V
Collector-Emitter Voltage	V_{ceo}	-25	V
Emitter-Base Voltage	V_{eb}	-6	V
Collector Current	I_c	-800	mA
Collector Power Dissipation	P_c	625	mW
Junction Temperature	T_j	150	$^\circ\text{C}$
Storage Temperature	T_{stg}	-55-150	$^\circ\text{C}$

Package: SOT-23

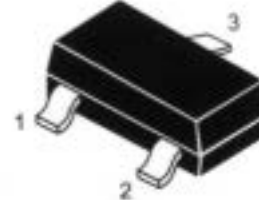

PIN:	1	2	3
STYLE			
NO.1	B	E	C

ELECTRICAL CHARACTERISTICS at $T_a = 25^\circ\text{C}$

Characteristic	Symbol	Min	Typ	Max	Unit	Test Conditions
Collector-Base Breakdown Voltage	BV_{cbo}	-40			V	$I_c = -100\mu\text{A}$ $I_e = 0$
Collector-Emitter Breakdown Voltage#	BV_{ceo}	-25			V	$I_c = -1\text{mA}$ $I_b = 0$
Emitter-Base Breakdown Voltage	BV_{ebo}	-6			V	$I_e = -100\mu\text{A}$ $I_c = 0$
Collector Cutoff Current	I_{cbo}			-100	nA	$V_{cb} = -40\text{V}$ $I_e = 0$
Emitter Cutoff Current	I_{ebo}			-100	nA	$V_{eb} = -5\text{V}$ $I_c = 0$
DC Current Gain	H_{fe1}	120		350		$V_{ce} = -1\text{V}$ $I_c = 100\text{mA}$
DC Current Gain	H_{fe2}	40				$V_{ce} = -1\text{V}$ $I_c = 800\text{mA}$
Collector-Emitter Saturation Voltage	$V_{ce(sat)}$			-0.6	V	$I_c = -800\text{mA}$ $I_b = -80\text{mA}$
Base-Emitter Saturation Voltage	$V_{be(sat)}$			-1.2	V	$I_c = -800\text{mA}$ $I_b = -80\text{mA}$
Current Gain-Bandwidth Product	f_T	100			MHz	$V_{ce} = -10\text{V}$ $I_c = -50\text{mA}$ $f = 30\text{MHz}$

* Total Device Dissipation : $FR = 1 \times 0.75 \times 0.062\text{in Board}$, Derate 25°C .

Pulse Test : Pulse Width $\leq 300\mu\text{s}$, Duty cycle $\leq 2\%$

CLASSIFICATION OF $H_{fe(1)}$

DEVICE MARKING:

SS8550=Y2

SS8550

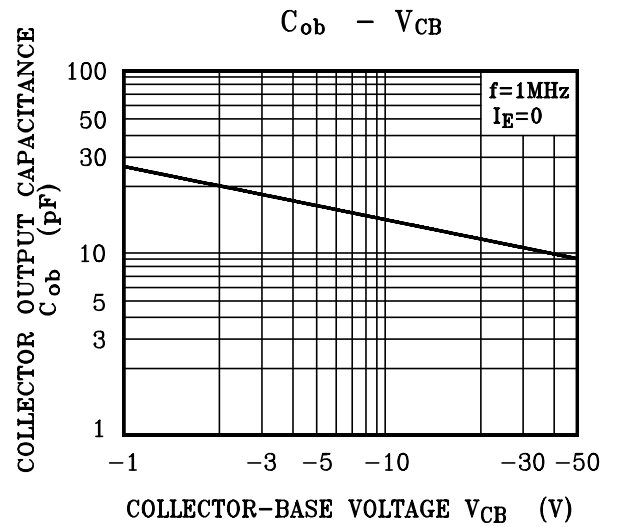
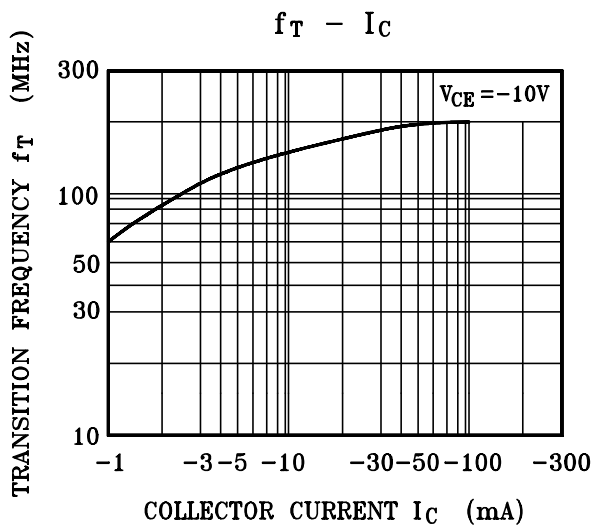
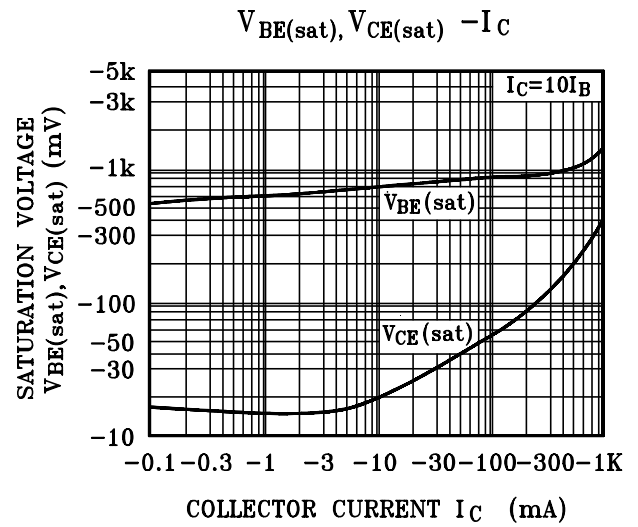
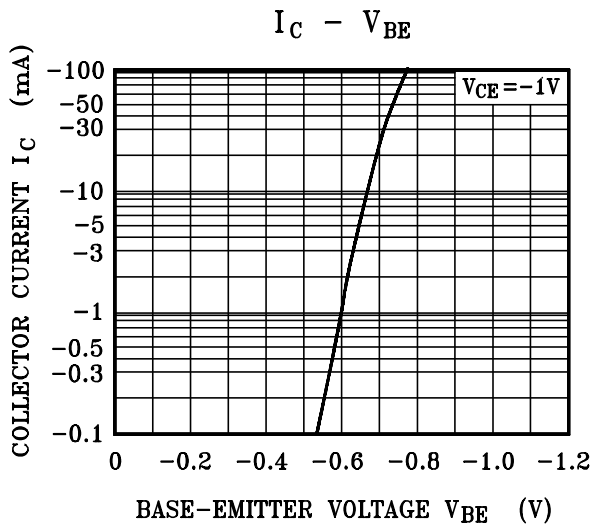
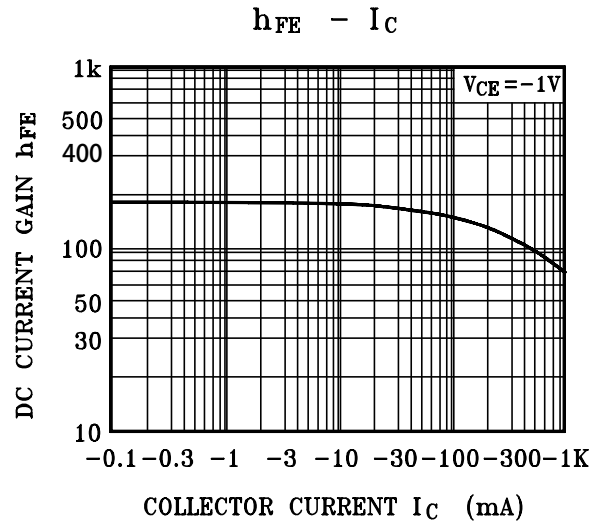
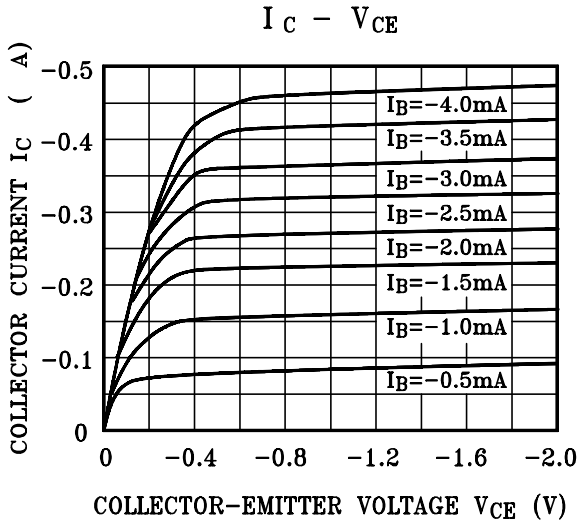

外型尺寸及内部结构图

OUTSIDE DEMENSION AND INTERNAL CONFIGURATION (SOT-23)

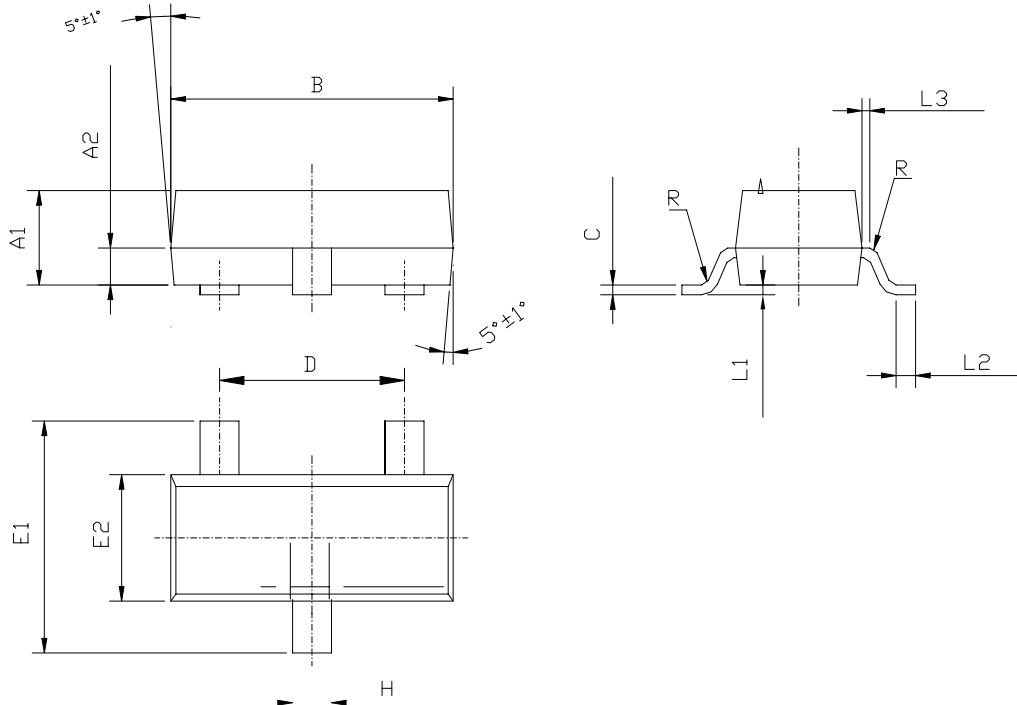

Symbol	Dimensions in Millimeters			内部结构 STYLS	管脚 PIN		
	Min	Nominal	Max		1 脚	2 脚	3 脚
A1	0.900	0.970	1.000	6	基极 BASE	发射极 EMITTER	集电极 COLLECTOR
A2	0.350	0.380	0.410		B	2.800	2.900
C	0.085	0.100	0.150	8	阳极 ANODE	不连接 NO- CONNECTION	阴极 CATHODE
D	1.800	1.900	2.000		D	1.800	1.900
E1	2.200	2.400	2.600	9	阳极 ANODE	阳极 ANODE	阴极 CATHODE
E2	1.200	1.300	1.400		E1	2.200	2.400
H	0.300	0.400	0.500	11	阳极 ANODE	阴极 CATHODE	阳极-阴极 ANODE-CATHODE
L1	0.000		0.100		H	0.300	0.400
L2	0.200			12	阴极 CATHODE	阴极 CATHODE	阳极 ANODE
L3	0.030	0.080	0.130		L1	0.000	
R	0.080TYP			18	不连接 NO- CONNECTION	阴极 CATHODE	阳极 ANODE
					R	0.080TYP	
				19	阴极 CATHODE	阳极 ANODE	阴极-阳极 CATHODE-ANODE

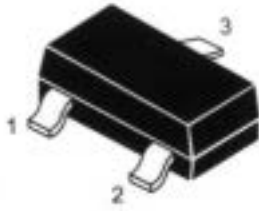

OUTSIDE

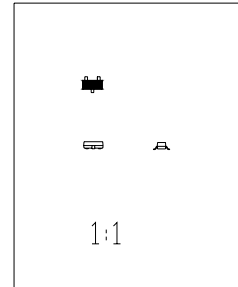

Scale 1:1 on letter size paper

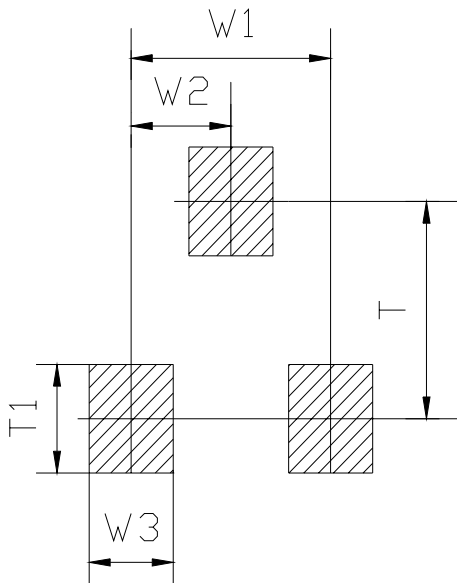

FOOTPRINTS FOR SOLDERING

Symbol	Dimensions in Millimeters	Dimensions in Inches
	Nominal	Nominal
W1	1.900	0.0748
W2	0.950	0.0374
W3	0.800	0.0315
T	2.000	0.0787
T1	1.000	0.0394

SOT-23 TAPE AND REEL DATA

SOT-23 PACKAGING:

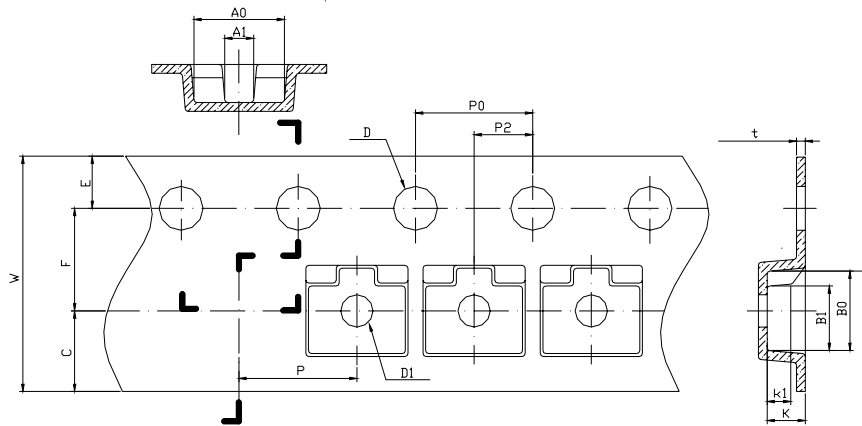
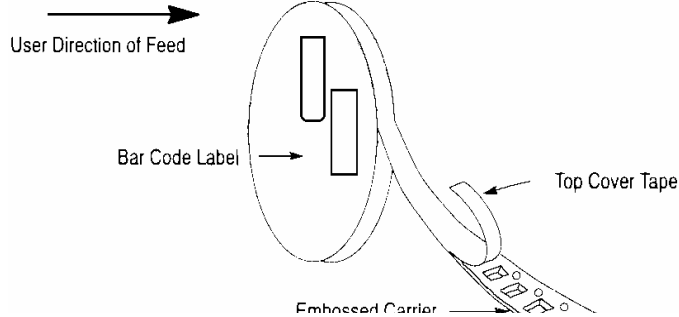

Symbol	Dimensions in Millimeters			Dimensions in Inches		
	Minimum	Nominal	Maximum	Minimum	Nominal	Maximum
A0	3.050	3.150	3.250	0.1201	0.1240	0.1280
A1	0.900	1.000	1.100	0.0354	0.0394	0.0433
B0	2.669	2.769	2.869	0.1051	0.1090	0.1130
B1	2.100	2.200	2.300	0.0827	0.0866	0.0906
C	2.750TYP			0.1083TYP		
D	1.500	1.500	1.600	0.0591	0.0591	0.0630
D1	0.900	1.000	1.100	0.0354	0.0394	0.0433
E	1.650	1.750	1.850	0.0650	0.0689	0.0728
F	3.450	3.500	3.550	0.1358	0.1378	0.1398
K	1.119	1.219	1.319	0.0441	0.0480	0.0519
K1	0.850TYP			0.03346TYP		
P	3.900	4.000	4.100	0.1535	0.1575	0.1614
P0	3.900	4.000	4.100	0.1535	0.1575	0.1614
P010	39.800	40.000	40.200	1.5669	1.5748	1.5827
P2	1.950	2.000	2.050	0.0768	0.0787	0.0807
t	0.216	0.229	0.242	0.0085	0.0090	0.0095
W	7.900	8.000	8.300	0.3110	0.3150	0.3268

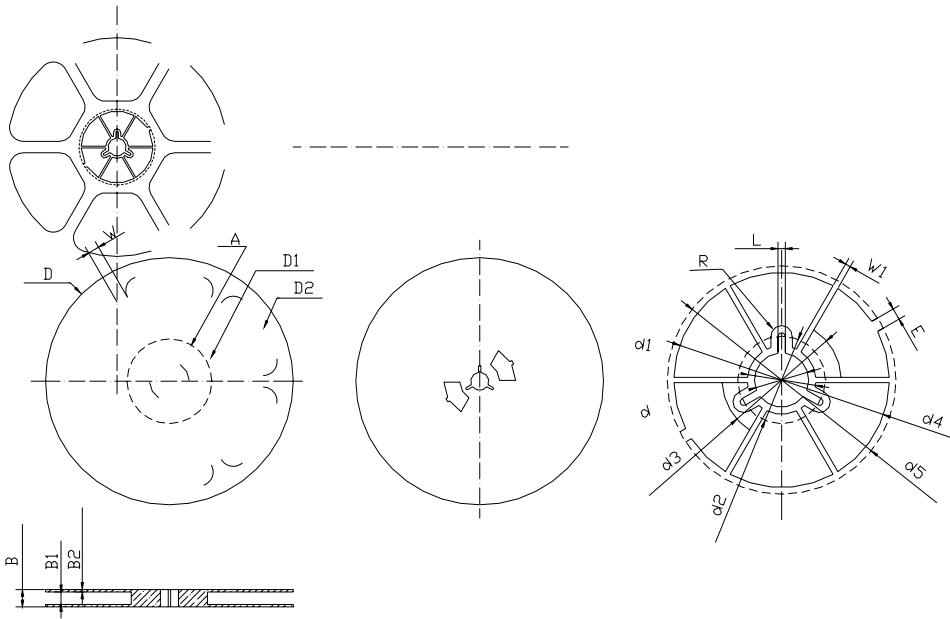

Symbol	Dimensions in Millimeters			Dimensions in Inches		
	Minimum	Nominal	Maximum	Minimum	Nominal	Maximum
B	-	-	12.500	-	-	0.4921
B1	8.900	9.000	9.100	0.3504	0.3543	0.3583
B2	1.700	1.750	1.800	0.0669	0.0689	0.0709
D	φ177.000	φ178.000	φ179.000	Φ6.9685	Φ7.0079	Φ7.0472
D1	Φ67.600TYP			Φ2.6614TYP		
D2	Φ157.600TYP			Φ6.2047 TYP		
d	Φ12.800	Φ13.000	Φ13.200	Φ0.5039	Φ0.5118	Φ0.5197
d1	Φ16.40 TYP			Φ0.6457 TYP		
d2	Φ21.000 TYP			Φ0.8268 TYP		
d3	Φ25.200 TYP			Φ0.99221TYP		
d4	Φ50.600	Φ51.600	Φ52.600	Φ1.9921	Φ2.0315	Φ2.0709
d5	Φ53.800	Φ54.800	Φ55.800	Φ2.1181	Φ2.1575	Φ2.1969
E	2.800 TYP			0.1102TYP		
L	1.750 TYP			0.0689 TYP		
R	2.575 TYP			0.1014 TYP		
W	15.000 TYP			0.5906 TYP		
W1	1.300 TYP			0.0512 TYP		