

**NPN digital transistor**  
**(Built-in resistor type)**

**ABSOLUTE MAXIMUM RATINGS at Ta=25°C**

Characteristic	Symbol	Rating	Unit
Supply Voltage	V <sub>CC</sub>	50	V
Input voltage	V <sub>IN</sub>	-10~+40	V
Output Current	I <sub>O</sub>	100	mA
Power dissipation	P <sub>D</sub>	200	mW
Junction Temperature Range	T <sub>J</sub>	-55-150	°C
Storage Temperature Range	T <sub>stg</sub>	-55-150	°C

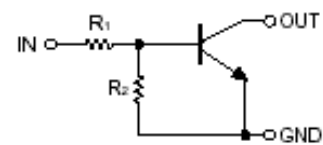
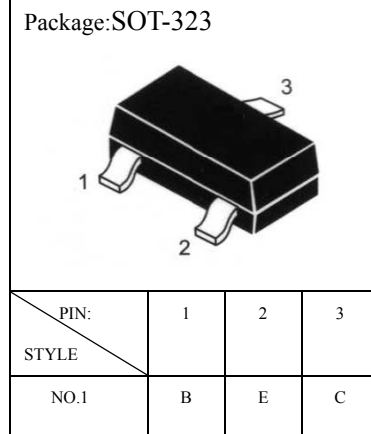

**ELECTRICAL CHARACTERISTICS at Ta=25°C**

Characteristic	Symbol	Min	Typ	Max	Unit	Test Conditions
Input Voltage	V <sub>I(off)</sub>			1.2	V	I <sub>O</sub> =100uA V <sub>O</sub> =5V
	V <sub>I(on)</sub>			2.4	V	I <sub>O</sub> = 5mA V <sub>O</sub> =0.2V
Output voltage	V <sub>O(on)</sub>		0.1	0.3	V	I <sub>O</sub> = 10mA I <sub>I</sub> =0.5mA
Input current	I <sub>I</sub>			0.88	mA	V <sub>I</sub> = 5V
Output current	I <sub>O(off)</sub>			0.5	uA	V <sub>O</sub> = 50V V <sub>I</sub> = 0V
DC Current Gain	H <sub>fe</sub>	30				V <sub>O</sub> = 5V I <sub>O</sub> = 10mA
Input resistance	R <sub>1</sub>	7	10	13	KΩ	
Resistance ratio	R <sub>2</sub> /R <sub>1</sub>	0.8	1	1.2		
Current Gain-Bandwidth Product	f <sub>T</sub>		250		MHz	V <sub>ce</sub> = 10V I <sub>e</sub> = -5mA, f=100MHz

\* Total Device Dissipation : FR=1x0.75x0.062in Board, Derate 25°C.

# Pulse Test : Pulse Width ≤300uS, Duty cycle ≤2%

DEVICE MARKING:

KRC102S=NB

●Electrical characteristic curves (Ta = 25°C)

Fig.1 Input voltage vs. output current (ON characteristics)

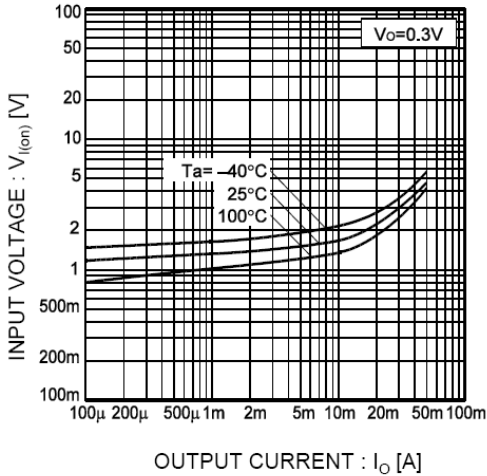

Fig.2 Output current vs. input voltage (OFF characteristics)

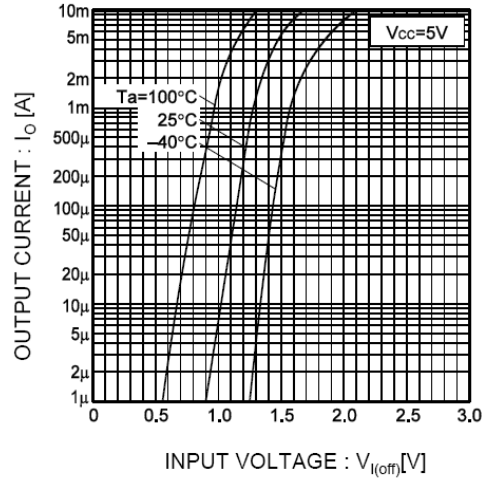

Fig.3 Output current vs. output voltage

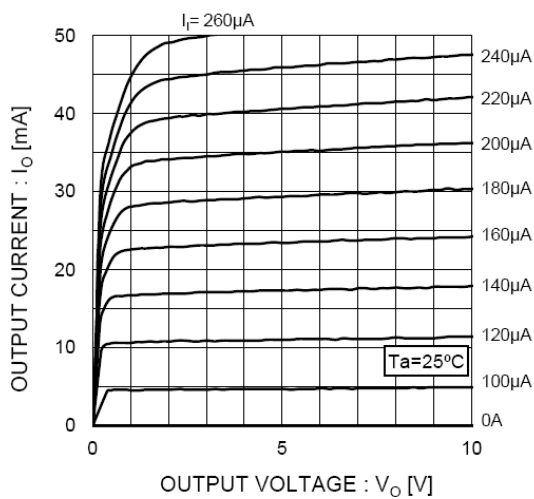
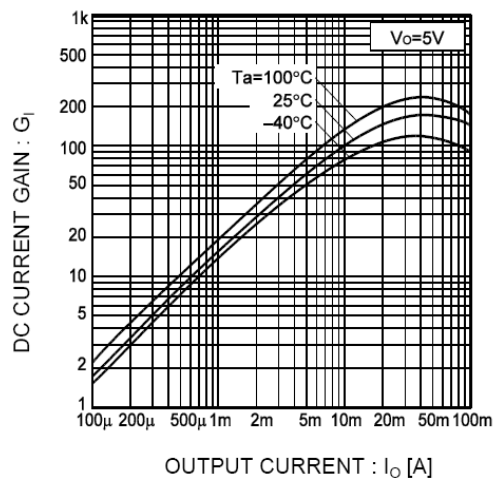
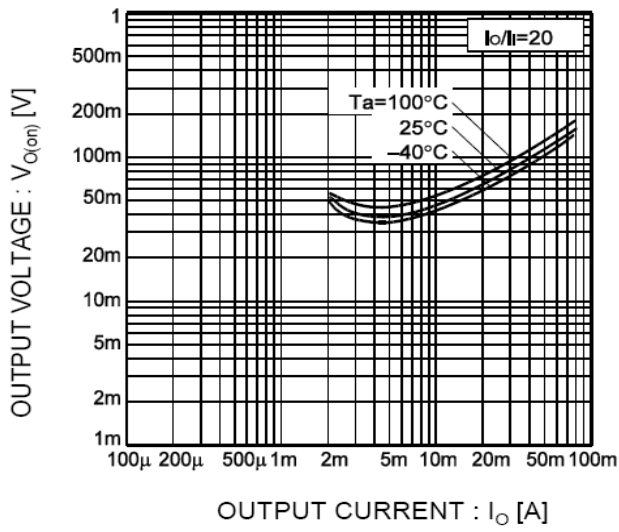

Fig.4 DC current gain vs. output current



● **Electrical characteristic curves (Ta = 25°C)**

Fig.5 Output voltage vs. output current



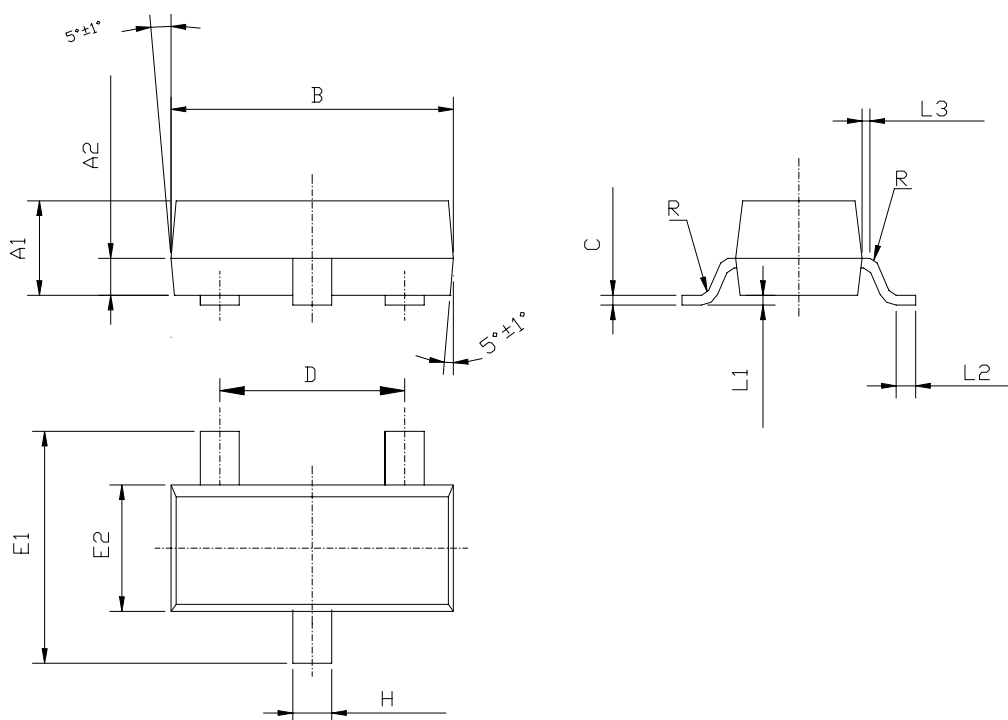

Symbol	Dimensions in Millimeters			内部结构 STYLS	管脚 PIN		
	Min	Nominal	Max		1 脚	2 脚	3 脚
A1	0.900	0.970	1.000	6	基极 BASE	发射极 EMITTER	集电极 COLLECTOR
A2	0.350	0.380	0.410		8	阳极 ANODE	不连接 NO- CONNECTION
B	2.800	2.900	3.000	9		阳极 ANODE	阳极 ANODE
C	0.085	0.100	0.150		11	阳极 ANODE	阴极 CATHODE
D	1.800	1.900	2.000	12		阴极 CATHODE	阴极 CATHODE
E1	2.200	2.400	2.600		18	不连接 NO- CONNECTION	阴极 CATHODE
E2	1.200	1.300	1.400	19		阴极 CATHODE	阳极 ANODE
H	0.300	0.400	0.500				
L1	0.000		0.100				
L2	0.200						
L3	0.030	0.080	0.130				
R	0.080TYP						

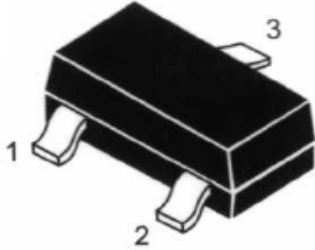

OUTSIDE

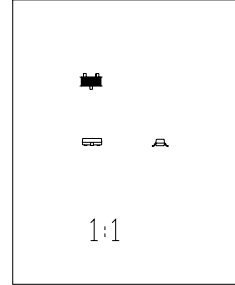

Scale 1:1 on letter size paper

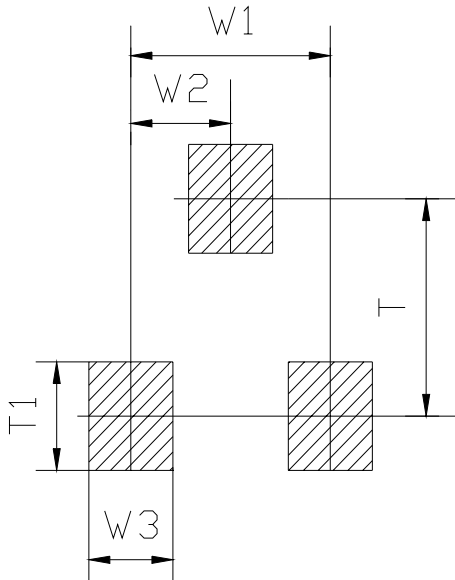

FOOTPRINTS FOR SOLDERING

Symbol	Dimensions in Millimeters	Dimensions in Inches
	Nominal	Nominal
W1	1.900	0.0748
W2	0.950	0.0374
W3	0.800	0.0315
T	2.000	0.0787
T1	1.000	0.0394

**SOT-23 PACKAGING:**

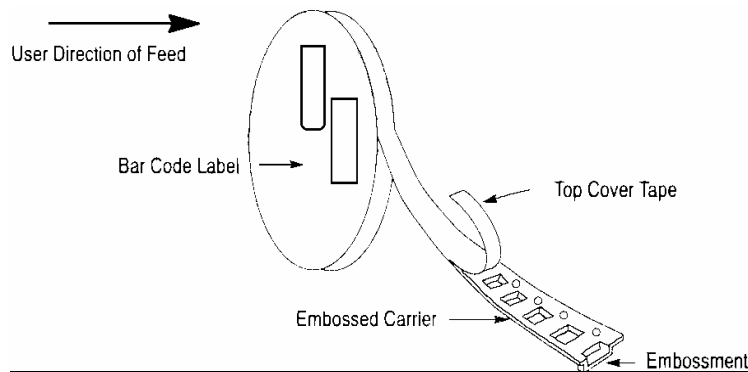

**SOT-23 EMBOSSED CARRIER TAPE:**

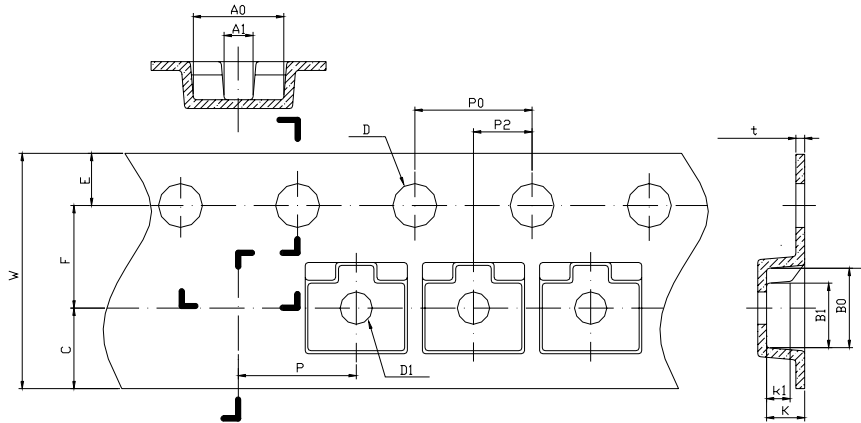

Symbol	Dimensions in Millimeters			Dimensions in Inches		
	Minimum	Nominal	Maximum	Minimum	Nominal	Maximum
A0	3.050	3.150	3.250	0.1201	0.1240	0.1280
A1	0.900	1.000	1.100	0.0354	0.0394	0.0433
B0	2.669	2.769	2.869	0.1051	0.1090	0.1130
B1	2.100	2.200	2.300	0.0827	0.0866	0.0906
C	2.750TYP			0.1083TYP		
D	1.500	1.500	1.600	0.0591	0.0591	0.0630
D1	0.900	1.000	1.100	0.0354	0.0394	0.0433
E	1.650	1.750	1.850	0.0650	0.0689	0.0728
F	3.450	3.500	3.550	0.1358	0.1378	0.1398
K	1.119	1.219	1.319	0.0441	0.0480	0.0519
K1	0.850TYP			0.03346TYP		
P	3.900	4.000	4.100	0.1535	0.1575	0.1614
P0	3.900	4.000	4.100	0.1535	0.1575	0.1614
P010	39.800	40.000	40.200	1.5669	1.5748	1.5827
P2	1.950	2.000	2.050	0.0768	0.0787	0.0807
t	0.216	0.229	0.242	0.0085	0.0090	0.0095
W	7.900	8.000	8.300	0.3110	0.3150	0.3268

**SOT-23 REEL DATA:**

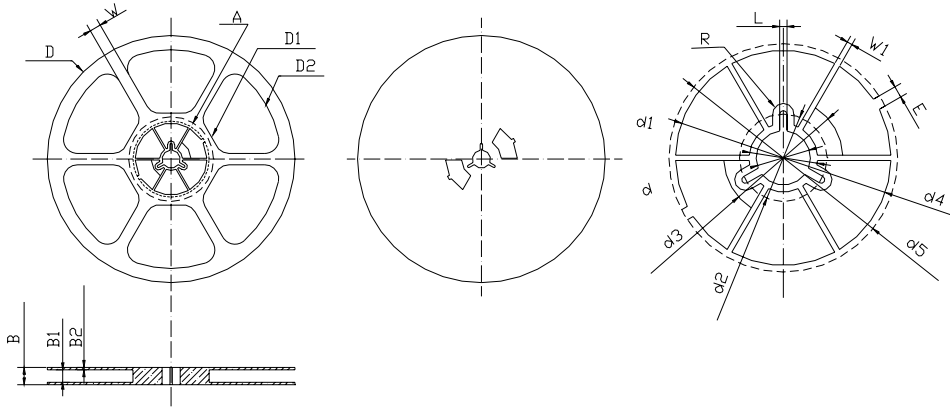

Symbol	Dimensions in Millimeters			Dimensions in Inches		
	Minimum	Nominal	Maximum	Minimum	Nominal	Maximum
B	-	-	12.500	-	-	0.4921
B1	8.900	9.000	9.100	0.3504	0.3543	0.3583
B2	1.700	1.750	1.800	0.0669	0.0689	0.0709
D	φ177.000	φ178.000	φ179.000	Φ6.9685	Φ7.0079	Φ7.0472
D1	Φ67.600TYP			Φ2.6614TYP		
D2	Φ157.600TYP			Φ6.2047 TYP		
d	Φ12.800	Φ13.000	Φ13.200	Φ0.5039	Φ0.5118	Φ0.5197
d1	Φ16.40 TYP			Φ0.6457 TYP		
d2	Φ21.000 TYP			Φ0.8268 TYP		
d3	Φ25.200 TYP			Φ0.99221TYP		
d4	Φ50.600	Φ51.600	Φ52.600	Φ1.9921	Φ2.0315	Φ2.0709
d5	Φ53.800	Φ54.800	Φ55.800	Φ2.1181	Φ2.1575	Φ2.1969
E	2.800 TYP			0.1102TYP		
L	1.750 TYP			0.0689 TYP		
R	2.575 TYP			0.1014 TYP		
W	15.000 TYP			0.5906 TYP		
W1	1.300 TYP			0.0512 TYP		